

PRESSURE TRANSDUCER

DESCRIPTION	PRESSURE RANGE bar	CONNECTION thread	DEVICE	PAGE
for differential pressure	0 ... 1 mbar / 10 bar	G $\frac{1}{8}$	D5	13.02
for gases and liquids	0 ... 50 mbar / 1000 bar	G $\frac{1}{8}$ - G $\frac{1}{2}$	D2	13.03
for non-corrosive media	0 ... 10 mbar / 5 bar	G $\frac{1}{8}$ m - G $\frac{3}{8}$ m	D7	13.03
for compressed air or liquids	0 ... -1 / 100 bar	G $\frac{1}{8}$ m - G $\frac{3}{8}$ m	D8	13.04
for corrosive media	0 ... 0.35 / 35 bar	G $\frac{1}{8}$ m - G $\frac{3}{8}$ m	D9	13.05
for high temperature, accurate to 0.1%	0 ... 50 mbar / 1000 bar	G $\frac{1}{4}$ m and G $\frac{1}{2}$ m	DA	13.06



13

Description	The operating pressure is converted into a proportional, electrical signal by a ceramics pressure transducer. After amplification the signal is monitored as an analogue voltage or current signal.	
Media	all non-corrosive media compatible with stainless steel, nylon, silicon, silicone and epoxy	
Supply voltage	12...32 V DC, residual ripple 5%, with reverse voltage protection, max. current consumption 4 mA	
Electrical connector	plug M12x1, 4-pin, with coupling socket	Protection class IP67 according to DIN EN60529
Output signal	4...20 mA: max. power consumption 260 mW	0...10 V: max. power consumption 50 mW
Linearity/Hysteresis	< 0.2 % FS typ. < 0.5 % FS	
Repeatability	< 0.2 % FS typ. < 0.3 % FS	
Long-term stability	< 0.5 % FS typ. < 1 % FS	
Temperature sensitivity	< 0.03% FS typ./°C < 0.08% FS/°C (0...50 °C)	
Vibration resistance	2 g at 5...500 Hz	
Temperature range	-25 °C to 85 °C / -13 °F to 185 °F	
Response time	5 ms for 10...90% of pressure range	
Material	Body: stainless steel 316L, mat. no. 1.4404	Shock resistance 50 g (11ms) Measuring cell: silicone and NBR/Buna-N o-ring

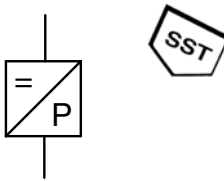

**accurate to 0.5%
compressed air or liquids**

Dimensions		Over-pressure	Measurement range	Order number for output signal	
B	Ø	max. bar	bar	4-20 mA	0-10 V
mm	mm				

for non-corrosive media			G ¹ / ₄ male, open sensor, with angular coupling socket	D7A 0.5% accurate	D7V
52	21.8	0.25	0... 10 mbar	D7A-B1*1	D7V-B1*1
		0.25	-10... 10 mbar	D7A-B1V*1	D7V-B1V*1
		0.35	0... 25 mbar	D7A-B2*1	D7V-B2*1
		0.35	-25... 25 mbar	D7A-B2V	D7V-B2V
		1	0... 70 mbar	D7A-B7*1	D7V-B7*1
		1	-70... 70 mbar	D7A-B7V	D7V-B7V
		1	0... 100 mbar	D7A-C1*1	D7V-C1*1
		1	0... 200 mbar	D7A-C2*1	D7V-C2*1
		1	0... 350 mbar	D7A-C3*1	D7V-C3*1
		1	-350... 350 mbar	D7A-C3V	D7V-C3V
		1	0... 600 mbar	D7A-C6*1	D7V-C6*1
		1	0... 800 mbar	D7A-C8*1	D7V-C8*1
		2	0... 1 bar	D7A-01	D7V-01
		2	-1... 1 bar	D7A-V1	D7V-V1



D7



KM12-C4-0

Special options, add the appropriate letter or number

deviant measurement range	to be indicated on order	D7 .- XX
G ¹ / ₄ male	connection thread	D7 .- . . 02
G ³ / ₈ male	connection thread	D7 .- . . 03
G ¹ / ₂ NPTa	connection thread	D7 .- . . N
G ¹ / ₄ NPTa	connection thread	D7 .- . . 02N

Accessories, enclosed

coupling socket 4-pin	M12x1, straight	KM12-A4-0	angular	KM12-C4-0
socket with cable	2 m, straight	KM12-A4-2	angular	KM12-C4-2
	5 m, straight	KM12-A4-5	angular	KM12-C4-5

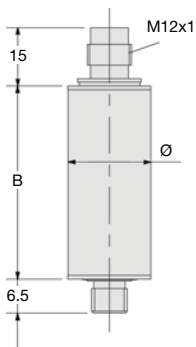

D7

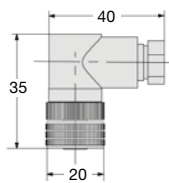

KM12-C4-0

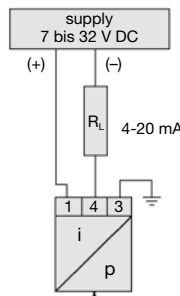

D7A

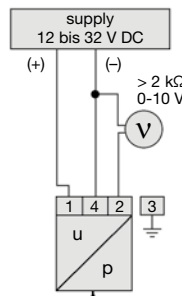

D7V

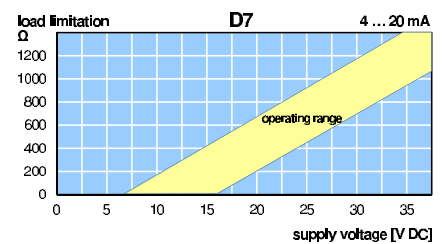

*1 Minimum order quantity 5 pieces

*2 Minimum order quantity 10 pieces

Test chart: see chapter "Technical information"

PDF CAD
www.aircom.net



Order example:
D7A-B1

Description	The operating pressure is converted into a proportional, electrical signal by a ceramics pressure transducer. After amplification the signal is monitored as an analogue voltage or current signal.	
Media	compressed air, non-corrosive gases or liquids compatible with ceramics and NBR/Buna-N	
Supply voltage	12...32 V DC, residual ripple 5%, with reverse voltage protection, max. current consumption 4 mA	
Electrical connector	plug M12x1, 4-pin, with coupling socket	Protection class IP67 according to DIN EN60529
Output signal	4...20 mA: max. power consumption 260 mW	0...10 V: max. power consumption 50 mW
Linearity/Hysteresis	< 0.1 % FS typ. < 0.2 % FS	Repeatability < 0.1 % FS typ. < 0.2 % FS
Long-term stability	< 0.1 % FS typ. < 0.3 % FS	
Temperature sensitivity	< 0.03% FS typ./°C < 0.06% FS/°C (0...70 °C)	
Vibration resistance	10 g at 5...500 Hz	
Temperature range	-25 °C to 85 °C / -13 °F to 185 °F	
Response time	5 ms for 10...90% of pressure range	Shock resistance 50 g (11ms)
Material	Body: stainless steel 316L, mat. no. 1.4404 Measuring cell: ceramics AL ₂ O ₃ and NBR/Buna-N o-ring	

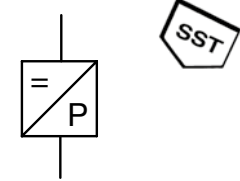

**accurate to 0.2%
compressed air or liquids**

Dimensions		Over-pressure	Measurement range	Order number for output signal	
B	Ø	max. bar	bar	4-20 mA	0-10 V
mm	mm				

for compressed air or liquids			G½ male, ceramic sensor, with angular coupling socket	D8A 0.2% accurate	D8V
52	21,8	1	0... 250	D8A- C2	D8V- C2
		1	0... 350*1	D8A- C3*1	D8V- C3*1
		1	0... 500*1	D8A- C5*1	D8V- C5*1
		2	0... -1	D8A- V0	D8V- V0
		2	-1... 1	D8A- V1	D8V- V1
		2	0... 1	D8A- 01	D8V- 01
		4	0... 2	D8A- 02	D8V- 02
		10	0... 5	D8A- 05	D8V- 05
		20	0... 10	D8A- 10	D8V- 10
		32	0... 16	D8A- 16*1	D8V- 16*1
		40	0... 20	D8A- 20*1	D8V- 20*1
		50	0... 25	D8A- 25*1	D8V- 25*1
		70	0... 35	D8A- 35*1	D8V- 35*1
		100	0... 50	D8A- 50*2	D8V- 50*2
		140	0... 70	D8A- 70*2	D8V- 70*2
		200	0... 100	D8A-100*2	D8V-100*2



D8



KM12-C4-0

Special options, add the appropriate letter or number

deviant measurement range	to be indicated on order	D8 . - XX
absolute pressure range	measurement range from 1 to 50 bar	D8 . . . A
G¼ male	connection thread	D8 . . . 02*2
G½ male	connection thread	D8 . . . 03*2
G½ NPTa	connection thread	D8 . . . N
G¼ NPTa	connection thread	D8 . . . 02N
for oxygen	pecially cleaned, max 40. bar	D8 . . . 15

Accessories, enclosed

coupling socket 4-pin	M12x1, straight	KM12-A4-0	angular	KM12-C4-0
socket with cable	2 m, straight	KM12-A4-2	angular	KM12-C4-2
	5 m, straight	KM12-A4-5	angular	KM12-C4-5

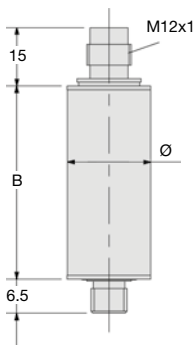

D8

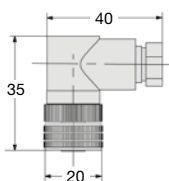

KM12-C4-0

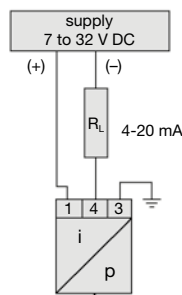

D8A

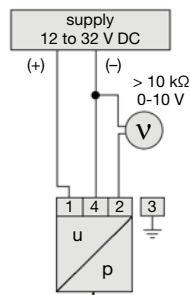

D8V

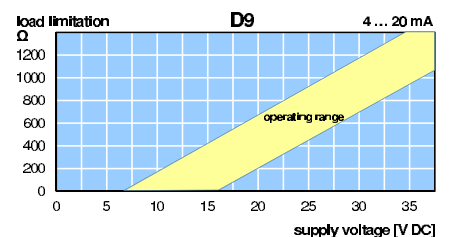

*1 Minimum order quantity 5 pieces

*2 Minimum order quantity 10 pieces

Test chart: see chapter "Technical information"

PDF CAD
www.aircom.net



Order example:
D8A-V0

Description	The operating pressure is converted into a proportional, electrical signal by a silicon pressure transducer. After amplification the signal is monitored as an analogue voltage or current signal.	
Media	all media compatible with stainless steel 316L, material no. 1.4404	
Supply voltage	12...32 V DC, residual ripple 5%, reverse voltage protection, max. current consumption 4 mA	
Electrical connection	plug M12x1, 4-pins, with coupling socket	
Outlet signal	4...20 mA: max. power consumption 260 mW	0...10 V: max. power consumption 50 mW
Linearity/Hysteresis	< 0.1 % FS typ.	
Repeatability	< 0.1 % FS typ.	
Long-term stability	< 0.1 % FS typ.	
Temperature sensitivity	< 0.03% FS typical per °C / K at 0 °C to 70 °C / 32 °F to 158 °F	
Response time	5 ms at 10...90% of measuring range	
Vibration sensitivity	10 g at 5...500 Hz	
Mounting position	any	
Material	Body/Diaphragm: stainless steel 316L, material no. 1.4404	
Shock resistance	50 g (11 ms)	
Protection class	IP 67 according to DIN EN60529	
Temperature range	-20 °C to 85 °C / -13 °F to 185 °F	



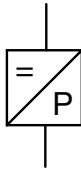

**0...35 bar, accurate to 0.3%
corrosive media**

Dimensions		Over-pressure	Measurement range	Order number for output signal	
B	Ø	max. bar	mbar / bar	4-20 mA	0-10 V

For corrosive media			G½ male, SST, relative pressure, with angular coupling socket	D9A	D9V
65	21,8	1	0...100 mbar	D9A-C1	D9V-C1
		1	-100...100 mbar	D9A-C1V*1	D9V-C1V*1
		1	0...200 mbar	D9A-C2	D9V-C2
		1	-200...200 mbar	D9A-C2V	D9V-C2V
		1	0...350 mbar	D9A-C3*1	D9V-C3*1
		1	-350...350 mbar	D9A-C3V*1	D9V-C3V*1
		2	0... 1 bar	D9A-01	D9V-01
		4	0... 2 bar	D9A-02*1	D9V-02*1
		10	0... 5 bar	D9A-05*1	D9V-05*1
		20	0... 10 bar	D9A-10	D9V-10
		32	0... 16 bar	D9A-16*1	D9V-16*1
		40	0... 20 bar	D9A-20	D9V-20
		70	0... 35 bar	D9A-35*1	D9V-35*1



D9



KM12-C4-0

Special options, add the appropriate letter or number

deviant measurement range	to be indicated on order	D9 . -XX
absolute pressure range	lowest measurement range 0...1 bar _{abs}	D9 . . . A*1
G¼ male	connection thread	D9 . . . 02*2
G¾ male	connection thread	D9 . . . 03*2
G½ NPTa	connection thread	D9 . . . N
G¼ NPTa	connection thread	D9 . . . 02N
for oxygen	specialy cleaned	D9 . . . 15

Accessories, enclosed

coupling socket 4-pin	M12x1, straight	KM12-A4-0	angular	KM12-C4-0
socket with cable	2 m, straight	KM12-A4-2	angular	KM12-C4-2
	5 m, straight	KM12-A4-5	angular	KM12-C4-5

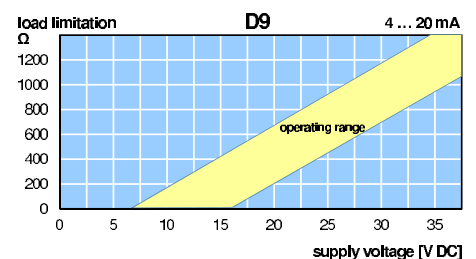
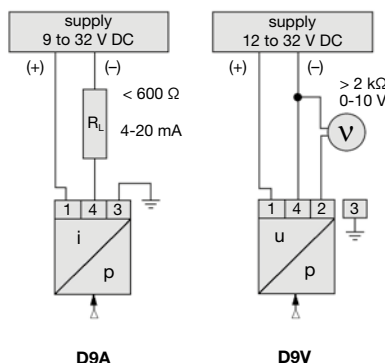
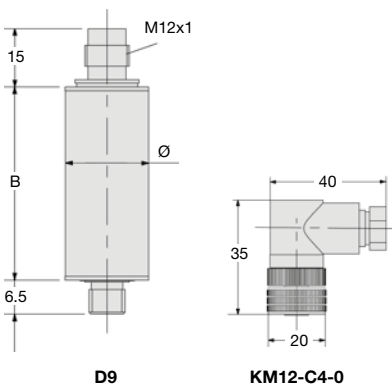

Test chart: see chapter "Technical information"

PDF CAD
www.aircom.net

 Order example:
D9A-C3

PRESSURE TRANSDUCER, 0.1% ACCURATE, FOR HIGH TEMPERATURES, ATEX

DA

Description	Pressure transducer in compact and robust stainless steel housing with piezo-resistive measuring element. Factory-made calibration of zero point and range is possible.
Media	compressed air, non-corrosive gases or liquids
Overpressure	max. 3x full scale, min. 3 bar, for DAA-D6 and DAA-E1 max. 1500 bar
Supply voltage	9...33 V DC at current signal, 15...30 V DC at voltage signal, residual ripple 5%, reverse voltage protection, short-circuit-proof
ATEX version	only current signal 10...30 V DC, max. 1 W, as per EN 50.014 / EN 50.020: 1974 A1...A5, ATEX 2640-1
Electrical connector	plug according to DIN 43650, with coupling socket
Output signal	4...20 mA: max. power consumption 260 mW, 0...10 V: max. power consumption 50 mW
Linearity/Hysteresis	< 0.1% FS
Temperature sensitivity	Repeatability < 0.1% FS Long-term stability < 0.1% FS, < 0.5% FS at version up to 500 mbar
Response time	< 0.02% FS per °C / K, < 0.06% FS at version up to 2 bar per °C / K, at range of 0 °C to 70 °C / 32 °F to 158 °F
Vibration resistance	1 ms for 10...90% of pressure range
Mounting position	10 g at 5...500 Hz
Material	any Shock resistance 50 g Protection class IP 65 Temperature range 0 °C to 70 °C / 32 °F to 158 °F
	Body/Diaphragm: stainless steel 316L, material no. 1.4435 O-rings: FKM, optionally EPDM

-1...1000 bar, accurate to 0.1 %
compressed air or gases

Dimensions			Accuracy	Measurement range	Order number	Measurement range	Order number
B	Ø	A/F	%	mbar/bar	4-20 mA	mbar/bar	4-20 mA

Pressure transducer				G½ male, SST, overpressure with angular coupling socket, 4-20 mA	DA		
73	24	27	0.1	0... 50 mbar	DAA-B5H		
				0... 100 mbar	DAA-C1H		
				0... 160 mbar	DAA-C2H	0... 10 bar	DAA-10H
				0... 250 mbar	DAA-C3H	0... 16 bar	DAA-16H
				0... 400 mbar	DAA-C4H	0... 25 bar	DAA-25H
				0... 600 mbar	DAA-C6H	0... 40 bar	DAA-40H
				0... 1.0 bar	DAA-01H	0... 60 bar	DAA-60H
				0... 1.6 bar	DAA-02H	0... 100 bar	DAA-D1H
				0... 2.5 bar	DAA-03H	0... 160 bar	DAA-D2H
				0... 4.0 bar	DAA-04H	0... 250 bar	DAA-D3H
				0... 6.0 bar	DAA-06H	0... 400 bar	DAA-D4H
						0... 600 bar	DAA-D6H
						0... 1000 bar	DAA-E1



DAA-C1H



DAA-C1T

Special options, add the appropriate letter or number

0-10 V output signal	not for Ex ATEX version	DAV-..	
deviant measurement range	to be indicated on order	DA..-XX	
absolute pressure range	from 50 mbar on	DA..-..A	
vacuum	0...-1 bar	DA..-..V	
Ex-Atex version	Ex II 1G Ex ia IIC T6	4...20 mA only	DAA-..EX
0.25 % linearity	for 100 mbar up to 600 bar		DA..-..G
	for 1000 bar		DA..-E1G
-25 to +100 °C/-13 to 212 °F	media temperature compensated up to 85 °C / 185 °F / T4		DA..-..S
-25 to +150 °C/-13 to 302 °F	media temperature compensated up to 85 °C / 185 °F / T3		DA..-..T
flush-mounted diaphragm	connection thread G½, also for vacuum, up to 600 bar		DA..-..F
G½ male	connection thread		DA..-..04
EPDM elastomer			DA..-..E
silicone-free oil-refill			DA..-..X32

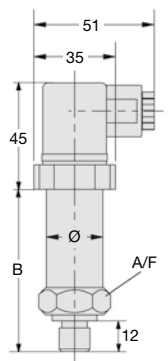

version	B (mm)
standard	73
standard 150 °C	100
Ex	122
Ex, T3	149

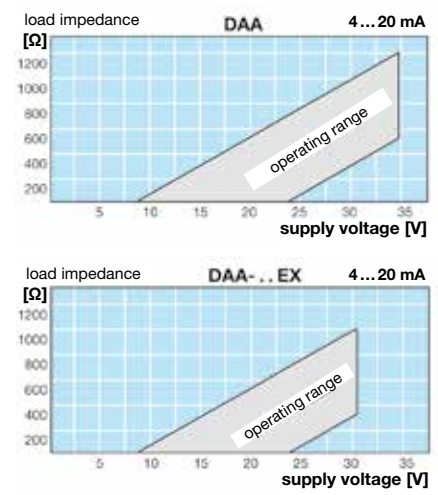
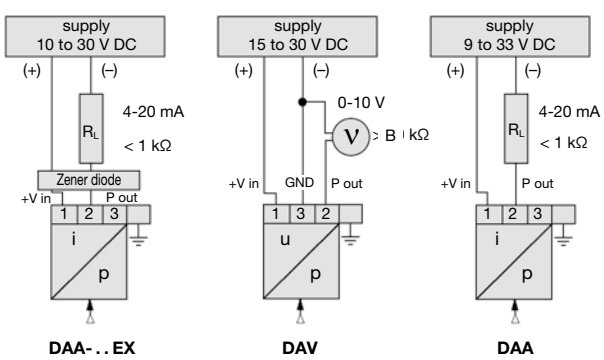

Test chart: see chapter "Technical information"

PDF CAD
www.aircom.net

Order example:
DAA-B5H

Description

The operating pressure is converted into a proportional, electrical signal by a ceramics stainless steel pressure transducer. After amplification the signal is monitored as an analogue voltage or current signal. compressed air, natural gases or liquids

Media

Supply voltage

12-33 V DC residual ripple 5%, with reverse voltage protection, max. current consumption 4 mA

Electrical connector

plug M12x1, 4-pin, with coupling socket

Protection class IP67 according to DIN EN60529

Output signal

4-20 mA: max. power consumption 260 mW

0-10 V: max. power consumption 50 mW

Repeatability

< 0,2% v.E

Long-term stability < 0,25% v.E

Temperature sensitivity

< 0,2% v.E

Vibration resistance 20 g at 15-2000 Hz

Ambient temperature

from -30 °C to 85 °C

Media temperature

from -40 °C to 125 °C

Shock resistance

100 g (11 ms)

Material

Body: Stainless steel 316L, mat. no. 1.4404 O-Ring: FKM, optionally EPDM
Coupling socket: Polyarylamid 50% GF UL 94 V-0 Measuring cell: Stainless steel (bar areas) ceramics AL₂O₃ (mbar/absolute pressure areas)

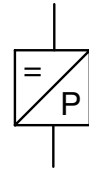

**accurate to 0.2%
compressed air or liquids**

Dimensions			Over-pressure	Under-pressure	Measurement range	Order number
B	Ø	SW	max. bar	max. bar	bar	(4-20 mA)
mm	mm	mm				

Miniature

G $\frac{1}{4}$ male stainless steel, for compressed air, natural gases or liquids, with angular coupling socket

D2

55	24	24	-1	3,0	-1 ... 0	bar	D2A-V00
				3,0	-1 ... 1	bar	D2A-V01
				4,8	-1 ... 1,5	bar	D2A-V02
				7,5	-1 ... 2,5	bar	D2A-V03
				18	-1 ... 5	bar	D2A-V05
				30	-1 ... 9	bar	D2A-V09
				48	-1 ... 15	bar	D2A-V15
				75	-1 ... 24	bar	D2A-V24
				3,0	0 ... 1	bar	D2A-01
				4,8	0 ... 1,6	bar	D2A-02
				7,5	0 ... 2,5	bar	D2A-03
				12	0 ... 4	bar	D2A-04
				18	0 ... 6	bar	D2A-06
				30	0 ... 10	bar	D2A-10
				48	0 ... 16	bar	D2A-16
				75	0 ... 25	bar	D2A-25
				120	0 ... 40	bar	D2A-40
				180	0 ... 60	bar	D2A-60
				300	0 ... 100	bar	D2A-D1
				480	0 ... 160	bar	D2A-D2
				750	0 ... 250	bar	D2A-D3
				1200	0 ... 400	bar	D2A-D4
				1500	0 ... 600	bar	D2A-D6
				1500	0 ... 1000	bar	D2A-E1



D2



KM12-C4-0

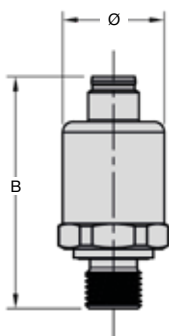

D2V-03

SW

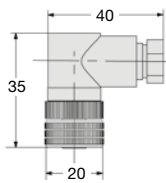

KM12-C4-0

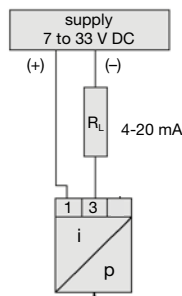

D2A

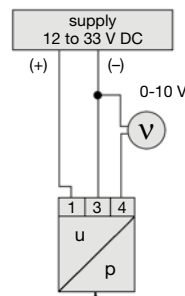

D2V



Description	The operating pressure is converted into a proportional, electrical signal by a ceramics stainless steel pressure transducer. After amplification the signal is monitored as an analogue voltage or current signal.		
Media	compressed air, natural gases or liquids		
Supply voltage	12-33 V DC	residual ripple 5%, with reverse voltage protection, max. current consumption 4 mA	
Electrical connector	plug M12x1, 4-pin, with coupling socket	Protection class IP67 according to DIN EN60529	
Output signal	4-20 mA: max. power consumption 260 mW	0-10 V: max. power consumption 50 mW	
Repeatability	< 0,2% v.E	Long-term stability < 0,25% v.E	
Temperature sensitivity	< 0,2% v.E	Vibration resistance 20 g at 15-2000 Hz	
Ambient temperature	from -30 °C to 85 °C		
Media temperature	from -40 °C to 125 °C		
Shock resistance	100 g (11 ms)		
Material	Body: Stainless steel 316L, mat. no. 1.4404	O-Ring: FKM, optionally EPDM	
	Coupling socket: Polyarylamid 50% GF UL 94 V-0	Measuring cell: Stainless steel (bar areas) ceramics AL ₂ O ₃ (mbar/absolute pressure areas)	

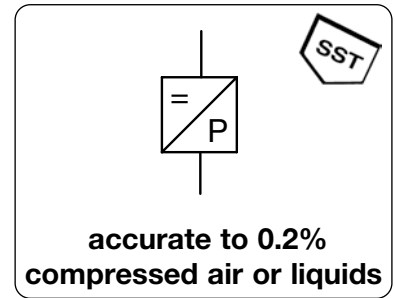

Dimensions			Over-pressure	Under-pressure	Measurement range	Oder number
B	Ø	SW	max. bar	max. bar	bar	(4-20 mA)
mm	mm	mm				

Miniature			G¼ male stainless steel, for compressed air, natural gases or liquids, with angular coupling socket			D2	
55	24	24	-0,3	2,0	-50 ...	50 mbar	D2A-B5V
					-100 ...	100 mbar	D2A-C1V
					-200 ...	200 mbar	D2A-C2V
					-300 ...	300 mbar	D2A-C3V
					-100 ...	0 mbar	D2A-VC1
					0 ...	50 mbar	D2A-B5
					0 ...	100 mbar	D2A-C1
					0 ...	200 mbar	D2A-C2
					0 ...	300 mbar	D2A-C3
					0 ...	400 mbar	D2A-C4
					0 ...	600 mbar	D2A-C6



D2



KM12-C4-0

Special options, add the appropriate letter or number

0-10 V output signal		D2 . . . V
deviant measurement range to be indicated on order		D2 . . XX
absolute pressure range measurement range from 0 ... 16 bar (Ceramic measuring cell)		D2 . . . A
flush-mounted diaphragm fully welded		D2 . . . F
G¼ male connection thread		D2 . . . 01
G½ male connection thread		D2 . . . 04
NPT connection thread		D2 . . . N
EPDM elastomers		D2 . . . E
for oxygen specially cleaned	from measurement range 1 bar	D2 . . . 15

Accessories, enclosed

coupling socket 4-pin	M12x1, straight	KM12-A4-0	angular	KM12-C4-0
socket with cable	2 m, straight	KM12-A4-2	angular	KM12-C4-2
	5 m, straight	KM12-A4-5	angular	KM12-C4-5

